

MUEBLES DE COLGAR

PERFIL GOLA "L"

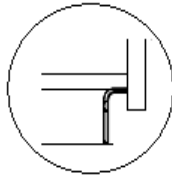

PERFIL ELBA

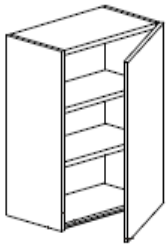
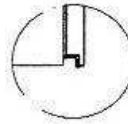

PERFIL GOLA SUPERIOR

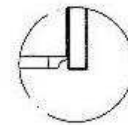

LA MODULACION PARA MUEBLES ALTOS PERMITE LA INSTALACION DE VARIOS TIPOS DE PERFIL, A ELEGIR POR EL CLIENTE. EN LA COMBINACION DE MUEBLES CORTOS UNO ENCIMA DE OTRO, LA MODULACION DEL INFERIOR SE HACE COMO EL RESTO DE MUEBLES DE COLGAR, PERO EN EL DE ARRIBA HABRIA QUE INSTALAR GOLA "L" ó UN PULSADOR (PUSH-PUSH).

MUEBLES BAJOS

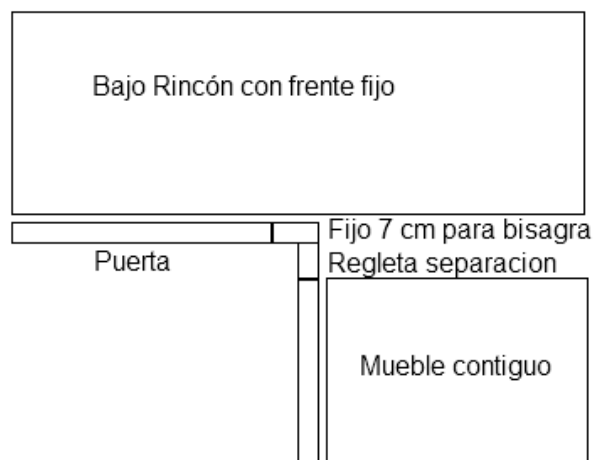
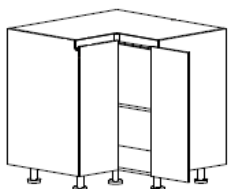
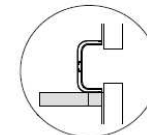
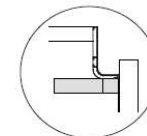
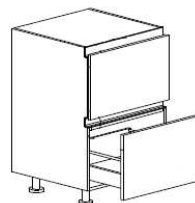
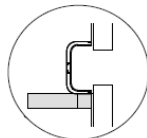
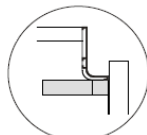
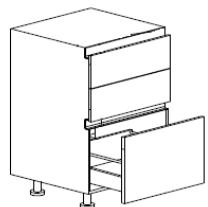
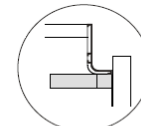
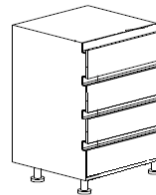
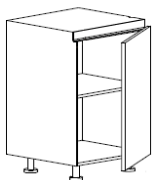

Los muebles de rincón con frente fijo, llevan un fijo de 7 cm para alojar las bisagras, y una separación mediante regleta con el mueble con el que se cruza y la Gola a inglete.

- BR DE 95 LA PUERTA ES DE 30
- BR DE 100 LA PUERTA ES DE 35
- BR DE 105 LA PUERTA ES DE 40
- BR DE 110 LA PUERTA ES DE 45

LA MODULACION PARA MUEBLES BAJOS SE REALIZA COMBINANDO LOS PERFILES GOLA "L" y "C", SEGÚN SU UBICACIÓN.

MUEBLES COLUMNA

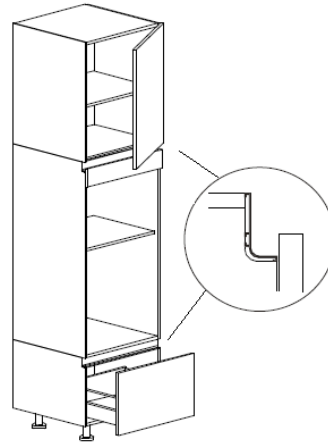
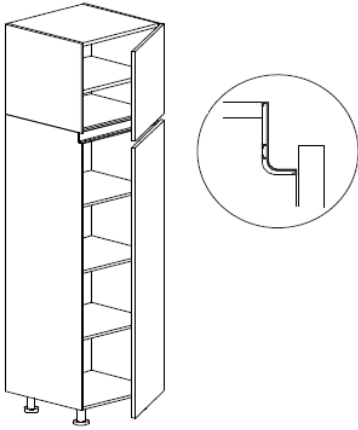

LA MODULACION PARA MUEBLES COLUMNA SE REALIZA DE FORMA SIMILAR A LA MODULACION DE MUEBLES BAJOS.

MUEBLES SEMICOLUMNA

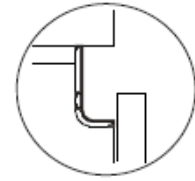
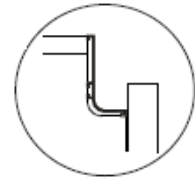
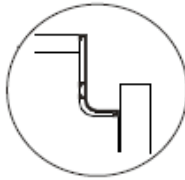
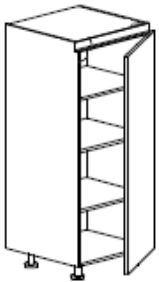

LA MODULACION PARA MUEBLES SEMICOLUMNA SE REALIZA DE FORMA SIMILAR A LA MODULACION DE MUEBLES BAJOS.

DETALLE DE MEDIDAS

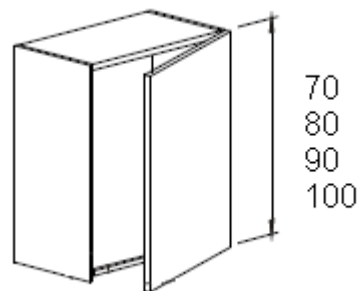
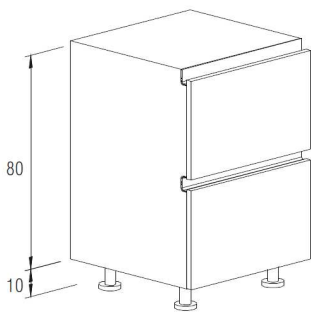

TIPOS DE PERFIL

PERFIL "C" Y ACCESORIOS



PERFIL ELBA

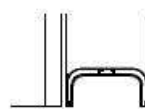

GOLA SUPERIOR

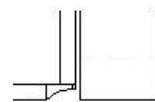

PERFIL "L" Y ACCESORIOS

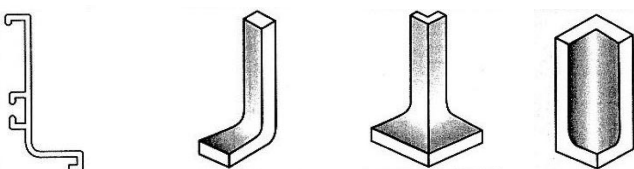

PERFIL INTERMEDIO PARA COLUMNAS

